

# INSTALLER MANUAL

Pellet Stove








©2024 CADEL srl | All rights reserved - Tutti i diritti riservati

**GRACE 7 - SPIRIT 5 - ROXY - ATRIUM 5 - TABLA - SOLO 5 - MADISON 5**

## SUMMARY

<b>1</b>	<b>MANUAL SIMBOLOGY.....</b>	<b>3</b>
<b>2</b>	<b>PACKAGING AND HANDLING.....</b>	<b>3</b>
2.1	PACKAGING .....	3
2.2	REMOVING THE STOVE FROM THE PALLET .....	3
2.3	STOVE HANDLING.....	4
<b>3</b>	<b>CHIMNEY FLUE .....</b>	<b>4</b>
3.1	PREPARING THE SMOKE EXPULSION SYSTEM.....	4
3.2	CHIMNEY COMPONENTS .....	4
3.3	SMOKE DUCT (SMOKE FITTING).....	5
3.4	FLUE (CHIMNEY OR PIPED DUCT) .....	5
3.5	CHIMNEY POT.....	6
3.6	MAINTENANCE .....	7
<b>4</b>	<b>COMBUSTION AIR .....</b>	<b>7</b>
4.1	AIR INLET .....	7
4.2	COMBUSTIBLE AIR INLET FOR SEALED-CHAMBER INSTALLATION .....	8
<b>5</b>	<b>EXAMPLES OF INSTALLATION (DIAMETERS AND LENGTHS TO BE SIZED) .....</b>	<b>9</b>
<b>6</b>	<b>INSTALLATION.....</b>	<b>10</b>
6.1	INTRODUCTION .....	10
6.2	MINIMUM DISTANCES.....	11
6.3	OVERALL DIMENSIONS .....	12
6.4	STOVE DOOR REMOVAL/INSTALLATION .....	15
6.5	GRACE <sup>3</sup> FRAME ASSEMBLING.....	16
6.6	FRAME DISASSEMBLY SPIRIT <sup>3</sup> - MADISON - SOLO 5 - TABLA .....	18
6.7	ROXY - ATRIUM PANEL DISASSEMBLY .....	19
6.8	UPPER EXHAUST GRACE.....	20
6.9	ASSEMBLY OF THE GRACE PEDESTAL (OPTIONAL) AND ROXY STAND .....	20
6.10	GRACE <sup>3</sup> WALL MOUNTING (OPTIONAL).....	21
6.11	ELECTRIC CONNECTION .....	22
6.12	CONNECTION TO THE EXTERNAL THERMOSTAT .....	22
6.13	CONNECTION TO THE EXTERNAL THERMOSTAT .....	23
6.14	STOVE CALIBRATION AND DEPRESSION MEASUREMENT .....	23
<b>7</b>	<b>SPECIAL MAINTENANCE .....</b>	<b>24</b>
7.1	INTRODUCTION .....	24
7.2	FUME CONDUIT CLEANING.....	24
7.3	FUME PASSAGES CLEANING.....	24
7.4	HOW TO CLEAN THE ROOM FAN .....	25
7.5	FUME PIPES ANNUAL CLEANING .....	26
7.6	GASKET REPLACEMENT.....	26
<b>8</b>	<b>IN CASE OF ANOMALY.....</b>	<b>27</b>
8.1	PROBLEM SOLVING .....	27
<b>9</b>	<b>TECHNICAL DATAS .....</b>	<b>29</b>
9.1	REPAIR INFORMATION .....	29
<b>10</b>	<b>FEATURES .....</b>	<b>30</b>

## 1 MANUAL SIMBOLOGY

	<b>USER</b>
	<b>AUTHORISED TECHNICIAN</b> <b>(ONLY to interpret or the Stove-manufacturer or the Authorized Technician of Technical Assistance Service approved by the Stove-manufacturer)</b>
	<b>SPECIALIZED STOVE-REPAIRER</b>
	<b>CAUTION:</b> <b>READ CAREFULLY THE NOTE</b>
	<b>CAUTION:</b> <b>DANGER OR IRREVERSIBLE DAMAGE POSSIBILITY</b>

- The icons with the stylized figures indicates whom the subject dealt in the paragraph is addressed to (between the User and/or the Authorized Technician and/or the Specialized Stove-repairer).
- WARNING symbols indicates an important note.

## 2 PACKAGING AND HANDLING

### 2.1 PACKAGING

- The packaging is made up of recyclable cardboard boxes according to RESY standards, recyclable expanded polystyrene inserts and wooden pallets.
- All packaging materials can be re-used for a similar use or eventually discharged as waste assimilable to the municipal solid ones, in accordance with current regulations.
- After having removed the packaging please assure you about the integrity of the product.

### 2.2 REMOVING THE STOVE FROM THE PALLET

Proceed as follows:



*Fig. 1 - Bracket removal*

- Remove the brackets which secure the feet of the stove (see **Fig. 1**). Then remove the stove from the pallet.

## 2.3 STOVE HANDLING

Both whether the stove is packed or not it is necessary to observe the following instructions for handling and transporting the stove from its sale point to its installation point and for any future movements:

- The stove must be handled with idoneous means paying attention to the existing safety regulations;
- do not turn the stove upside down and/or upset it on one side, but keep it in vertical position or as accorded with the constructor instructions;
- if the stove is made up of ceramic, stone, glass or any particularly fragile material components, all must be moved with the utmost care.

## 3 CHIMNEY FLUE

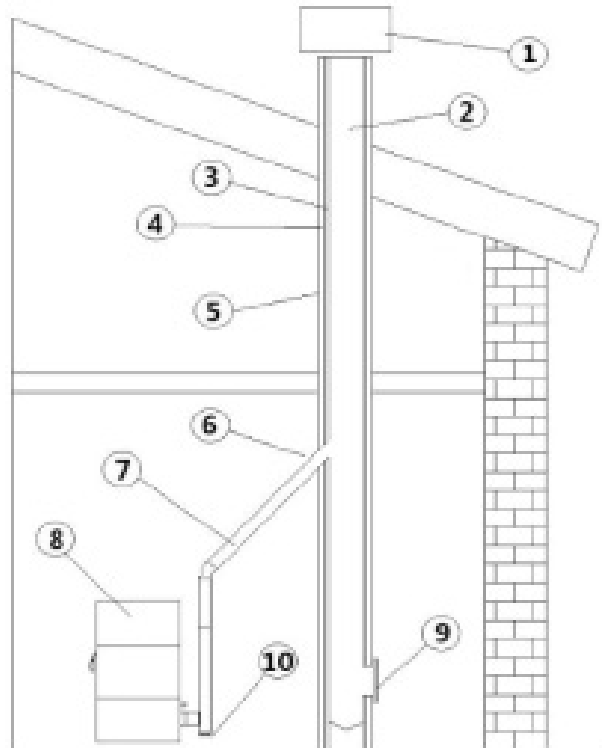
### 3.1 PREPARING THE SMOKE EXPULSION SYSTEM

The combustion product expulsion system is a particularly important element for the proper operation of the appliance and must be correctly sized according to EN 13384-1.

Its creation/adaptation/verification must always be carried out by a legally qualified operator and must comply with the regulations in force in the country where the appliance is installed.

The Manufacturer declines all liability for malfunctions caused by a badly sized and non-compliant smoke expulsion system.

### 3.2 CHIMNEY COMPONENTS



**Fig. 2 - Chimney components**

<b>LEGEND</b>	<b>Fig.2</b>
<b>1</b>	<i>Chimney pot</i>
<b>2</b>	<i>Fume outlet</i>
<b>3</b>	<i>Chimney flue</i>
<b>4</b>	<i>Termal insulation</i>
<b>5</b>	<i>External wall</i>
<b>6</b>	<i>Chimney union</i>
<b>7</b>	<i>Fume pipe</i>
<b>8</b>	<i>Heat generator</i>
<b>9</b>	<i>Inspection door</i>
<b>10</b>	<i>T-union with inspection plug</i>

### 3.3 SMOKE DUCT (SMOKE FITTING)

The smoke duct is the pipe that connects the appliance to the flue.

This smoke fitting must comply in particular with the following requirements:

- comply with product standard EN 1856-2;
- its cross-section must be of constant diameter and no less than that of the appliance outlet, from the firebox outlet up to the connection in the flue;
- the horizontal section must be as short as possible and extend no more than 4 metres;
- the horizontal sections must have a minimum upward slope of 3%;
- changes of direction must have an angle no greater than 90° and be easy to inspect
- the number of changes of direction, including that for entry into the flue, and exclusion of the T in the event of a side or rear outlet, must not exceed 3;
- it must be insulated if it passes outside the installation room
- it must not in any case cross rooms in which it is forbidden to install combustion appliances.
- the use of flexible metal and fibre cement or aluminium hoses is forbidden;

In any case, smoke ducts must be sealed against combustion products and any condensation. For this reason, it is recommended to use pipes with silicone gaskets or similar sealing devices that withstand the operating temperatures of the appliance (e.g. T200 P1) and that by removing the gaskets, are still T400 N1 G certified.

SYSTEM TYPE	Ø80 mm PIPE	Ø100 mm PIPE
Minimum vertical length	1,5 mt	2 mt
Maximum length (with 1 union)	6,5 mt	10 mt
Maximum length (with 3 unions)	4,5 mt	8 mt
Maximum number of unions	3	3
Level section (minimum inclination 3%)	4 mt	4 mt
Installation at a height above 1200 m a.s.l.	NO	Obligatory

### 3.4 FLUE (CHIMNEY OR PIPED DUCT)

When creating the flue, in particular comply with the following requirements:

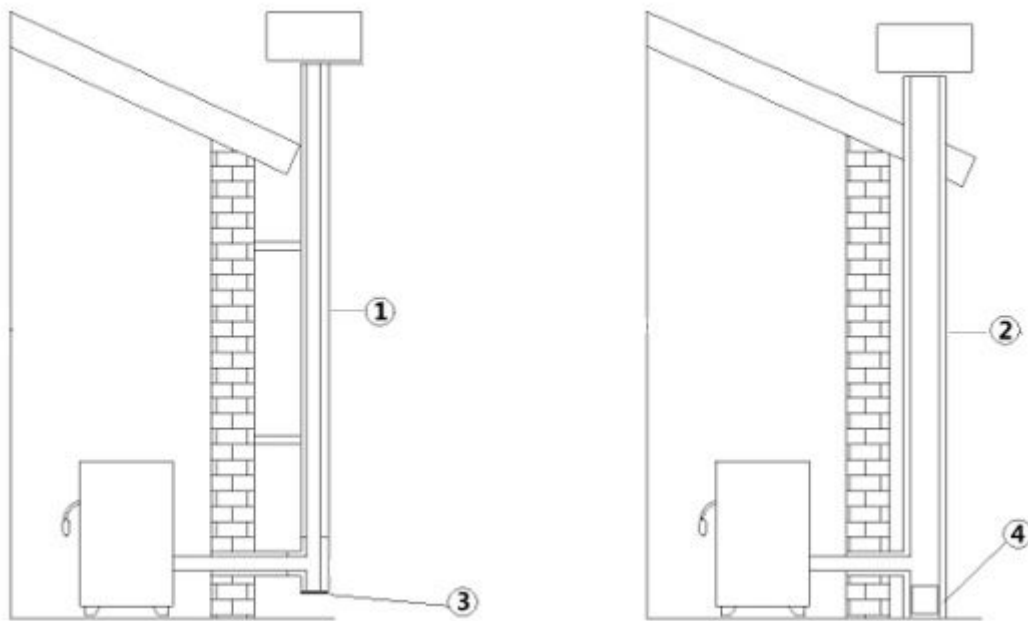
- comply with the applicable product standard (EN 1856, EN 1857 EN 1457, EN 1806, EN 13063..);
- be made with suitable materials to ensure resistance to normal mechanical, chemical, thermal stresses and have adequate thermal insulation in order to limit the formation of condensate;
- have a predominantly vertical configuration and be free of choke points along its entire length;
- be correctly spaced by air gaps and isolated from combustible materials;
- the flue inside the house must still be insulated and can be inserted in an air shaft provided it complies with the regulations for piping;
- the smoke duct must be connected to the flue by means of a Tee fitting with an inspectable collection chamber for the collection of soot and any condensate.
- where the sizing provides for wet operation, a suitable condensate collection and siphon discharge system must be set up.



***We recommend checking the data plates of the flue for the safety distances that must be observed in the presence of combustible materials and, if necessary, the type of insulating material to be used.***

***It is forbidden to connect the stove to a collective or shared flue with other combustion appliances or with hood outlets.***

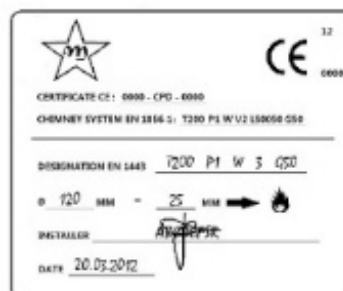
***It is forbidden to use the direct drain on the wall or towards indoor spaces and any other form of drain not provided for by the regulation in force in the country of installation.***



**Fig. 3 - Chimney Flues**

LEGEND	Fig. 3
1	Chimney flue with insulated stainless-steel pipes
2	Chimney flue on the existing chimney
3	Inspection plug
4	Inspection door

- The chimney flue must be provided CE in accordance with EN 1443 regulation. Please find attached an example of label:



**Fig. 4 - Example of label**

### 3.5 CHIMNEY POT

The chimney pot, meaning the end part of the flue, must meet the following characteristics:

- the smoke outlet section must be at least double the internal section of the chimney;
- prevent the penetration of rain or snow;
- ensure the outlet of smoke even in the event of wind (windproof chimney pot);
- the height of outflow must be beyond the reflux area (\*\*\*) (refer to national regulations to identify the reflux area);
- always be built at a distance from antennas or dishes, and never be used as a support.

(\*\*\*) unless there are specific national derogations (clearly specified in the corresponding instruction manual in English) which under appropriate conditions allow it; in this case, strictly follow the product/installation requirements of the relative regulations/technical specifications/legislation in force in that country.

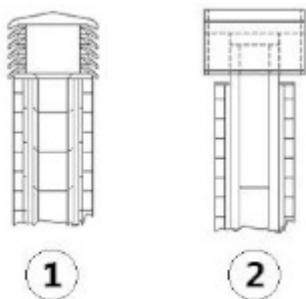


Fig. 5 - Anti-wind chimney pots

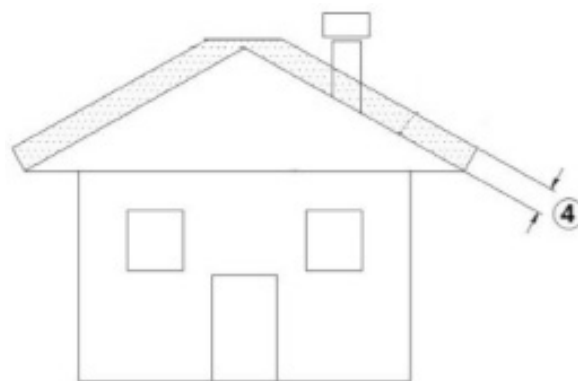


Fig. 6 - Reflux area

### 3.6 MAINTENANCE

- The fumes extraction pipes (fumes conduit + chimney flue + chimney pot) must always be cleaned, scrubbed and checked by an expert stove-repairer, in compliance with current regulations, with the instructions of the stove-manufacturer and the directives of your insurance company.
- In case of doubts, please follow the most restrictive regulations.
- Have your chimney flue and chimney pot checked and cleaned by an expert chimney sweep at least once a week. The chimney sweep has to release a written declaration about the security of the system.
- Not cleaning compromise safety.

## 4 COMBUSTION AIR

### 4.1 AIR INLET

It is mandatory to provide an adequate external air inlet that supplies the combustion air required for the product to work properly. The flow of air between the outside and the installation room can take place with a free air inlet or by channelling the air directly to the outside (\*\*\*)

The free air inlet must be:

- be made at floor level and in any case not higher than the height of the appliance;
- always be protected with an outer grille and in such a way that it cannot be obstructed by any object;
- have a minimum total free area of 80 cm<sup>2</sup> (net of the grille);

The presence of other suction devices (e.g.: vmc, electric fan for stale air extraction, kitchen hood, other stoves, etc.), in the same room, or in communicating rooms of the same housing unit, could cause negative pressure in the room. In this case, with the exception of sealed installations, one must verify that, with all the equipment on, no more than 4 Pa of negative pressure is created inside the installation room with respect to the outside. If necessary, increase the air inlet section.

It is possible to duct the air required for combustion to the outside by connecting the external air inlet directly with the combustion air inlet which is usually found on the back of the appliance.

The external ducted air vents must be:

- made close to the floor and anyway not higher than the appliance
- protected by a grille that guarantees a clear surface equal to the cross-section of the duct and made so that it cannot be obstructed by any object
- The air vent can be made directly on a wall of the installation room communicating with the outside, or indirectly in adjacent rooms that permanently communicate with the installation room, according to that set forth by standards in force.

The duct must comply with the following dimensions (each 90° bend is equivalent to one linear metre):

(\*\*\*) In the event the combustion air is ducted on unsealed products, still verify that no more than 4 Pa of negative pressure is created inside the installation room with respect to the outside, otherwise provide for an additional air intake in the room.

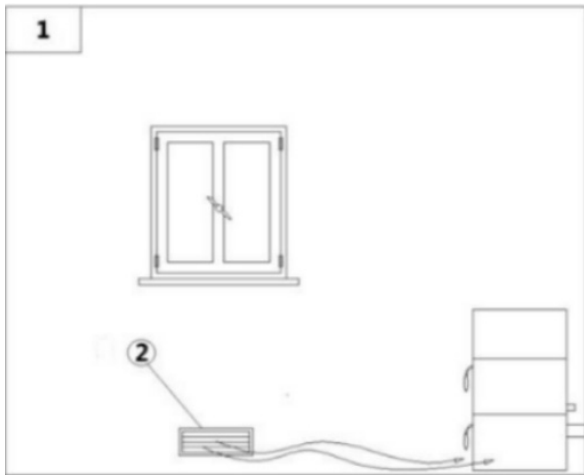
#### Below 15 kW:

Air duct diameter	Maximum length (smooth duct)	Maximum length (corrugated duct)
50 mm	2 m	1 m
60 mm	3 m	2 m
80 mm	7 m	4 m

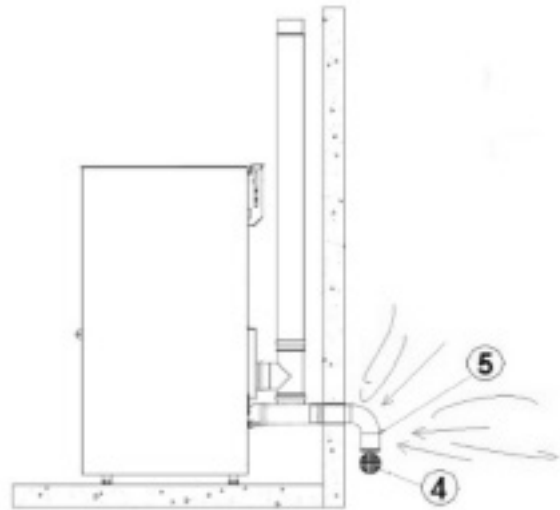
Air duct diameter	Maximum length (smooth duct)	Maximum length (corrugated duct)
100 mm	12 m	9 m

**Above 15 kW:**

Air duct diameter	Maximum length (smooth duct)	Maximum length (corrugated duct)
50 mm	-	-
60 mm	1 m	-
80 mm	3 m	1 m
100 mm	7 m	4 m



**Fig. 7 - Direct air inflow**



**Fig. 8 - Air inlet for sealed-chamber installation**

LEGEND	Fig. 7 Fig. 8
1	Room to ventilate
2	External air inlet
4	Shield grid
5	Curve inlet to turn downwards

**4.2 COMBUSTIBLE AIR INLET FOR SEALED-CHAMBER INSTALLATION**

How to connect to the stove in the sealed chamber with concentric system:

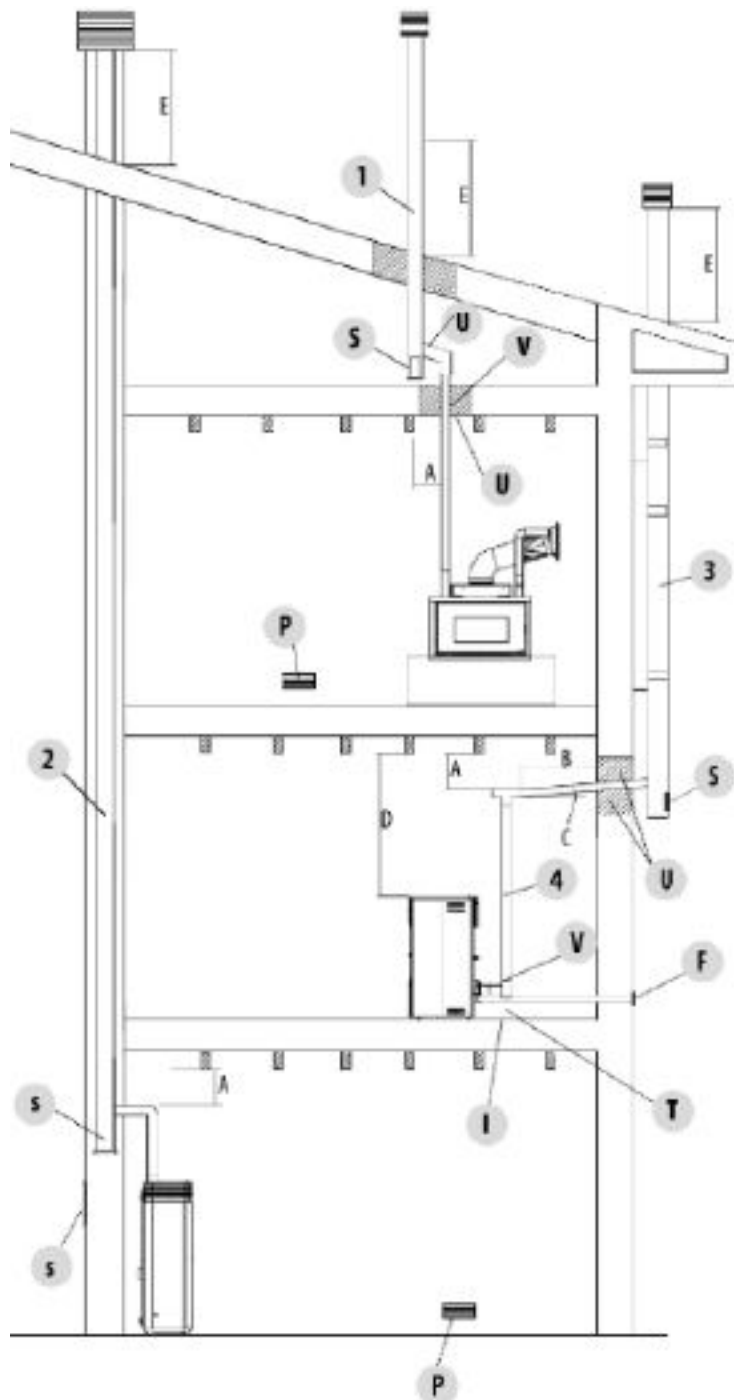


**Fig. 9 - Phase1**

- Connect the air intake pipe to the combustion air pipe of the stove and tighten everything with a clamp (see [Fig. 9]).



## 5 EXAMPLES OF INSTALLATION (DIAMETERS AND LENGTHS TO BE SIZED)



**Fig. 10 - Chimney flue**

**1.** Flue installation with hole for the passage of the pipe increased by: minimum 100mm around the pipe if next to non-flammable parts such as cement, brick, etc.; or minimum 300mm around the pipe (or as required by plate data) if next to flammable parts such as wood etc. In both cases, install suitable insulation between the flue and the ceiling. Always check and comply with the plate data of the flue, specifically the minimum safety distances from combustible materials. The previous rules also apply for holes made in walls.

**2.** Old flue, pipe with the inclusion of an external access door for chimney cleaning.

**3.** External flue made of insulated stainless-steel pipes, i.e. with double walls: all securely mounted on the wall. With windproof chimney pot.

**4.** Ducting system using Tee fittings that allow easy access for cleaning without having to remove the pipes.

LEGEND	Fig. 10
<b>U</b>	Insulation
<b>V</b>	Possible diameter increase
<b>I</b>	Inspection cap
<b>S</b>	Inspection access panel
<b>P</b>	Air inlet
<b>T</b>	Tee fitting with inspection cap
<b>A</b>	Distance from flammable material (smoke duct plate)
<b>B</b>	Maximum 4 m
<b>C</b>	Minimum 3° slope
<b>D</b>	Distance from flammable material (appliance plate)
<b>E</b>	Reflux area
<b>F</b>	Air ducting



The instructions in this chapter refer explicitly to the Italian installation regulation UNI 10683. In any case, always observe the regulations in force in the country of installation.

## 6 INSTALLATION

### 6.1 INTRODUCTION

**The heating system (generator + combustion air supply + combustion product expulsion system + any hydraulic/aerualic system) must be installed in compliance with the laws and regulations in force (\*), and carried out by a qualified technician, who must issue a declaration of conformity of the system to the system manager and shall undertake full responsibility for final installation and consequent good operation of the product.**

The manufacturer declines all responsibility in the event of installations that do not comply with the laws and regulations in force and inappropriate use of the appliance.

In particular one must ensure that:

- the environment is suitable for installing the appliance (floor load-bearing capacity, presence or possibility of creating an adequate electrical/hydraulic/aerualic system when required, volume compatible with the appliance characteristics, etc.);
- the appliance is connected to a smoke expulsion system correctly sized according to EN 13384-1, which is resistant to soot fire and which complies with the distances prescribed by the combustible materials indicated on the plate data;
- there is a suitable combustion air flow to the appliance;
- other combustion appliances or extraction devices installed do not cause a negative pressure of more than 4 Pa in the room where the product is installed compared to the outside (only sealed appliances are allowed a maximum of 15 Pa of negative pressure in the room).

(\*): *The national reference standard for the installation of domestic appliances is UNI 10683 (IT) - DTU NF 24.1 (FR) - DIN 18896 (DE) - NBN B 61-002 (BE) - Real Decreto 1027/2007 (ES) - Paesi Bassi (NL) Bouwbesluit - Danmark (DK) BEK n° 541 del 27/04/2020.*

**In particular, it is recommended to strictly observe the safety distances from combustible materials to avoid serious harm to people and to the integrity of the home.**

Installation of the appliance must ensure easy access to service the appliance itself, the smoke channels and the flue. Always maintain adequate distance and protection in order to prevent the product from coming into contact with water.

**It is forbidden to install the stove in rooms with a fire hazard.**

**With the exception of sealed installations, it is also forbidden for liquid fuel appliances with continuous or intermittent operation that draw the combustion air from the room they are installed in or B-type gas heating appliances, with or without the production of domestic hot water, to coexist in the same room or in interconnecting rooms.**



**Sealed installation means that the product is certified as sealed and its installation (ducting of the combustion air and connection to the chimney) is airtight with respect to the installation environment.**

A sealed installation does not consume the room's oxygen because it draws all the air from the outer environment (if suitably ducted) and makes it possible to install the product in all houses that require a high degree of insulation such as "passive" or "high energy efficiency" houses. Thanks to this technology there is no risk of smoke emissions in the room and no air inlets - hence not even the relevant ventilation grilles - are required in the installation premises. Consequently, there will be more draughts of cold air in the room, thus making it more comfortable and increasing the overall efficiency of the system. The sealed stove in a sealed installation is compatible with the presence of forced ventilation or premises that might have negative pressure with respect to the outside.

## 6.2 MINIMUM DISTANCES

Observe the distances from flammable objects (sofas, furniture, wood panelling, etc..) as specified in the following diagram. If objects considered to be particularly sensitive to heat are present, such as furniture, curtains or sofas, as a precaution, increase the stove clearances substantially to avoid possible deterioration due to the effect of heat.

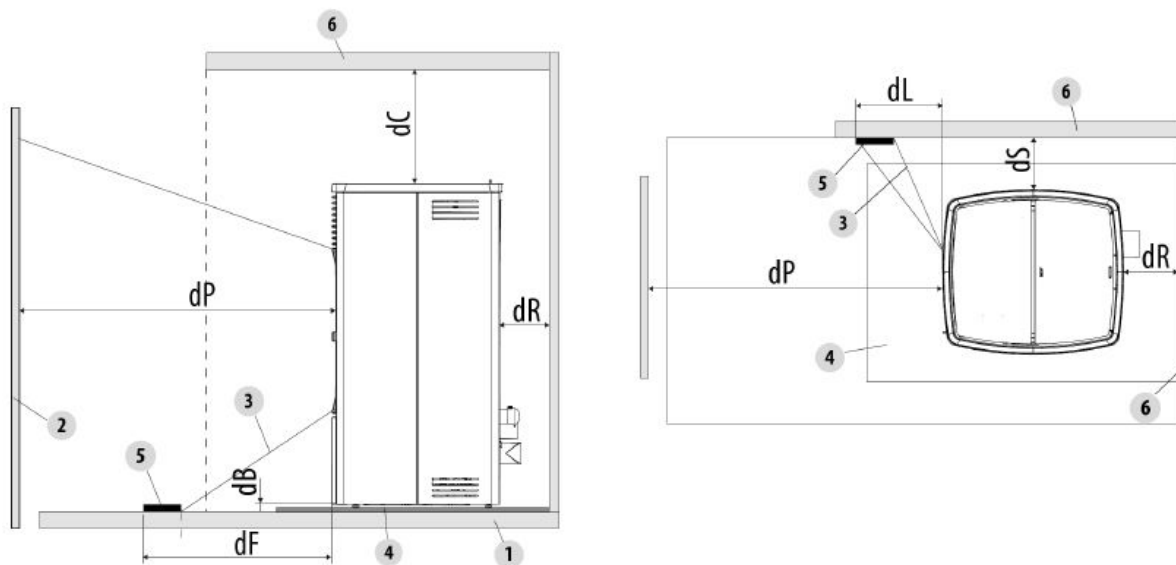


Fig. 11 - Safety distances from combustible material.

.LEGENDA	Fig. 11
<b>dR (rear distance)</b>	40 mm
<b>dS (side distance)</b>	300 mm
<b>dB (lower distance)</b>	15 mm
<b>dC (upper distance)</b>	750 mm
<b>dP (front radiation)</b>	1000 mm
<b>dF (floor radiation)</b>	1000 mm
<b>dL (side radiation)</b>	1000 mm
<b>1</b>	FLOOR
<b>2</b>	FRONT FLAMMABLE MATERIAL
<b>3</b>	AREA SUBJECT TO RADIATION
<b>4</b>	FLOOR GUARD
<b>5</b>	RADIATED SURFACE TO BE PROTECTED
<b>6</b>	REAR/SIDE/UPPER FLAMMABLE SURFACE

If the floor is made of combustible material, use a protection made of non-combustible material (steel, glass...) that also protects the front from any falling combusted material during cleaning operations.



**Always fit a floor guard if the floor is made of flammable material.**

Install the stove also detached from any non-combustible walls/surfaces, observing a minimum clearance of **40mm** (back) and **300mm** (side) to allow effective aeration of the appliance and a good distribution of heat in the room.

In any case, ensure adequate distance to facilitate access during cleaning and extraordinary maintenance. If this is not possible, it must still be possible to distance the product from adjacent walls/elements.

This operation (1\*) must be performed by a technician qualified to disconnect the combustion product expulsion ducts and their subsequent restoration.

For generators connected to the hydraulic system, a connection must be provided between the system itself and the product so that, during extraordinary maintenance, carried out by a qualified technician, it is possible to move the generator 1 by at least 50 cm from adjacent walls without emptying the system (e.g. by using a double shut-off gate or suitable flexible connection).

(1\*) The national reference standard for the installation of domestic appliances is UNI 10683 (IT) - DTU NF 24.1 (FR) - DIN 18896 (DE) - NBN B 61-002 (BE) - Real Decreto 1027/2007 (ES) Paesi Bassi (NL) Bouwbesluit - Danmark (DK) BEK n° 541 del 27/04/2020.

### 6.3 OVERALL DIMENSIONS

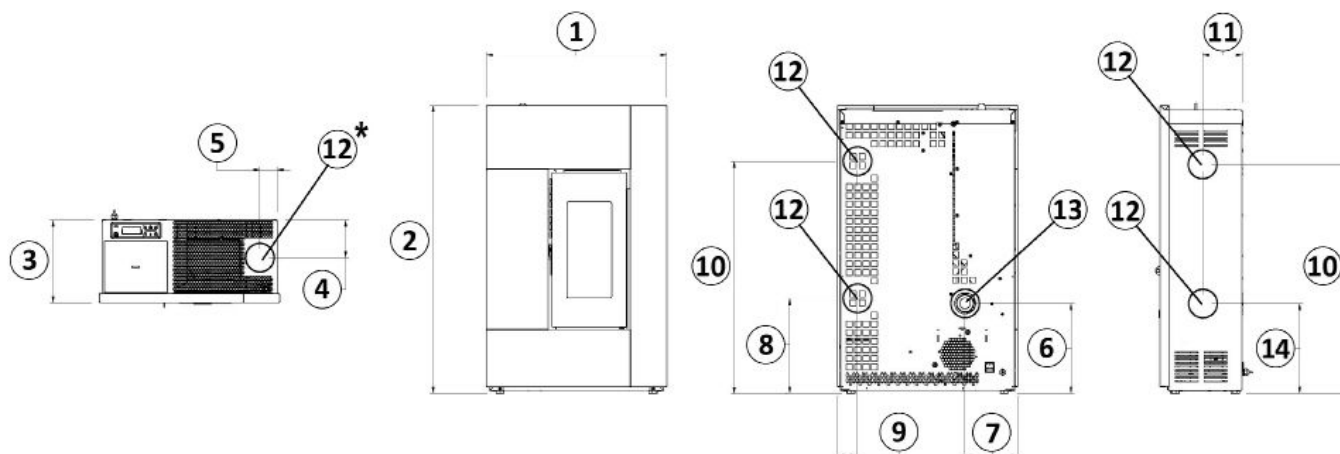


Fig. 12 - General dimensions: Spirit<sup>3</sup>

LEGEND	Fig. 12
1	60 cm
2	95,5 cm
3	27,5 cm
4	12,5 cm
5	5,9 cm
6	30,6 cm
7	17 cm
8	31,5 cm
9	6,6 cm
10	76 cm
11	13,2 cm
12	Exhaust fumes d.8 cm
13	Hole combustion air inlet d.6 cm
14	31 cm

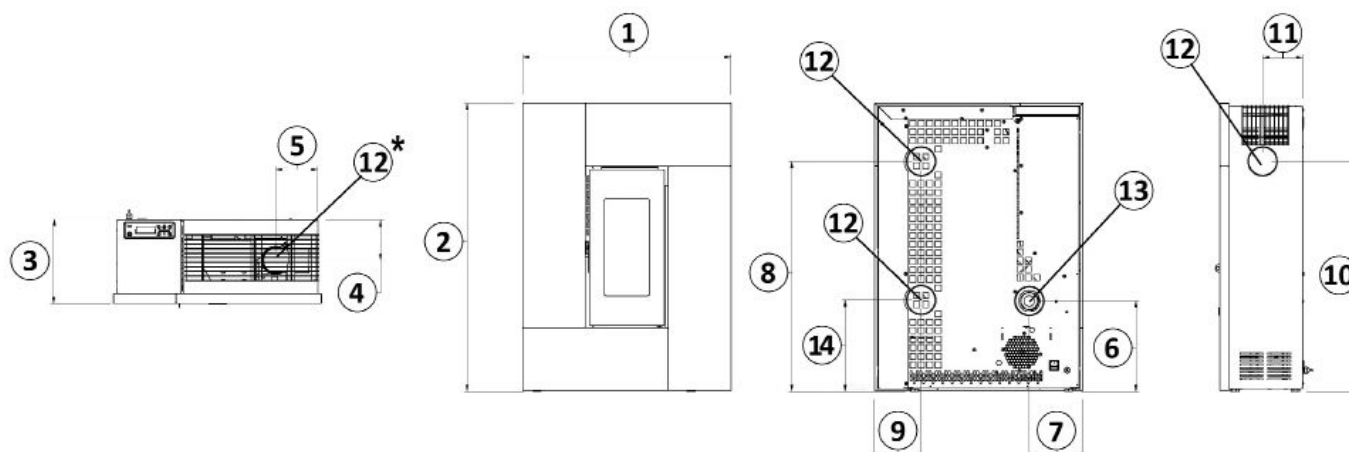
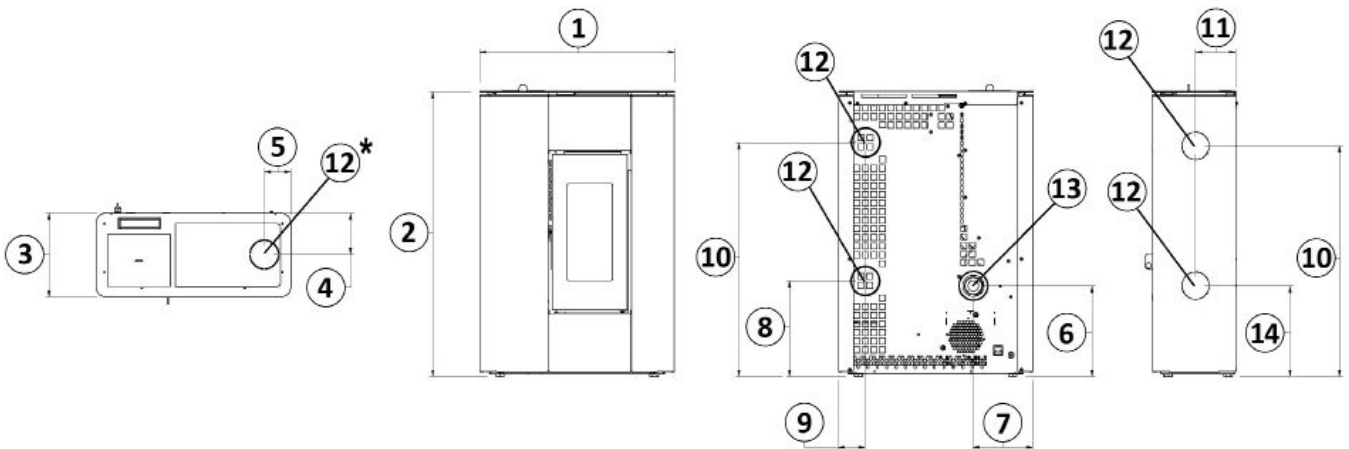


Fig. 13 - General dimensions: Grace<sup>3</sup>

**LEGEND Fig. 13**

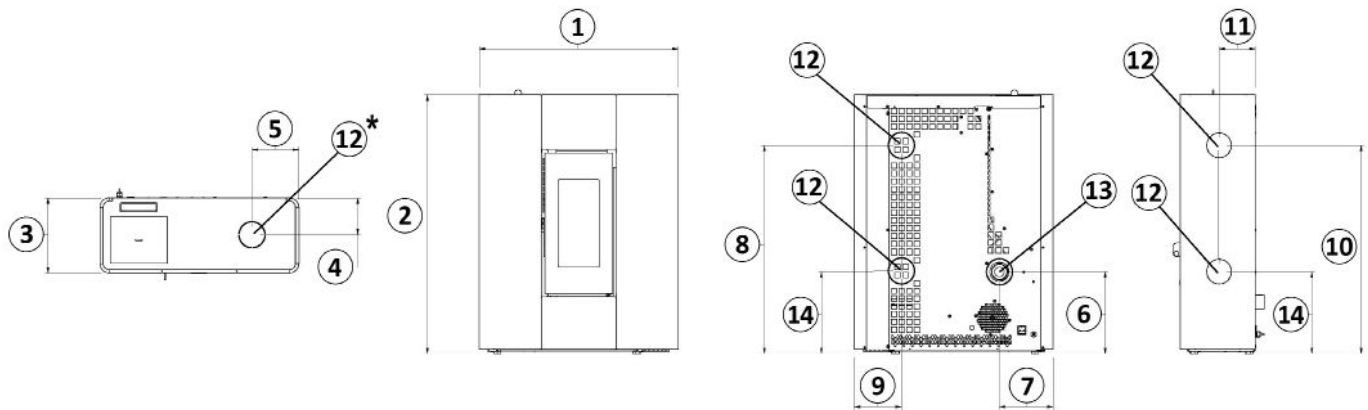
<b>1</b>	69 cm
<b>2</b>	95,2 cm
<b>3</b>	27,3 cm
<b>4</b>	13,3 cm
<b>5</b>	14 cm
<b>6</b>	29,7 cm
<b>7</b>	17,3 cm
<b>8</b>	76 cm
<b>9</b>	14,1 cm
<b>10</b>	76 cm
<b>11</b>	13,3 cm
<b>12</b>	Exhaust fumes d.8 cm
<b>13</b>	Hole combustion air inlet d.6 cm
<b>14</b>	31 cm



**Fig. 14 - General dimensions: Atrium**

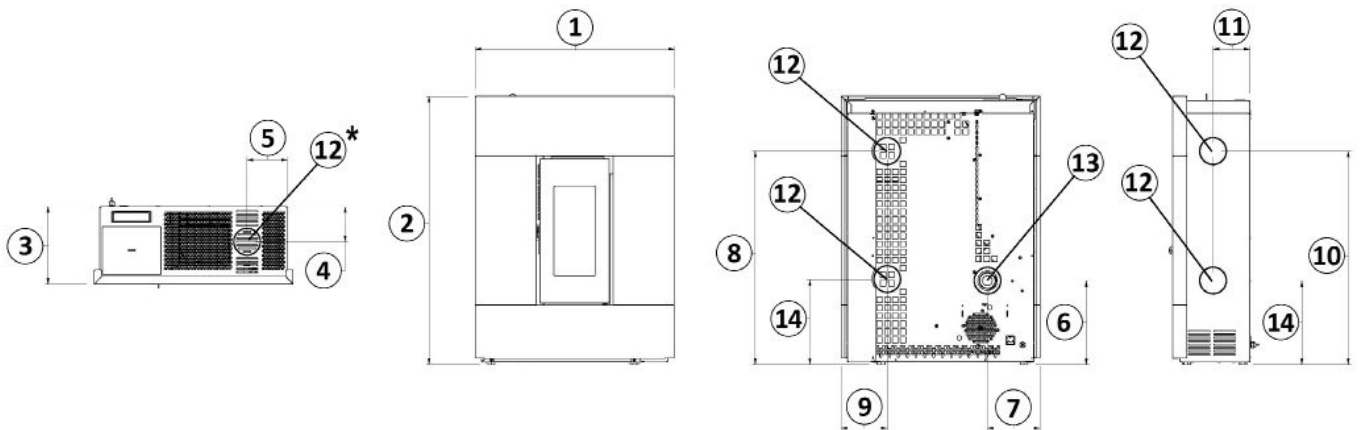
**LEGEND Fig. 14**

<b>1</b>	64,5 cm
<b>2</b>	94 cm
<b>3</b>	27,7 cm
<b>4</b>	13,7 cm
<b>5</b>	8,8 cm
<b>6</b>	29,8 cm
<b>7</b>	19,7 cm
<b>8</b>	31,5 cm
<b>9</b>	8,8 cm
<b>10</b>	76 cm
<b>11</b>	13,2 cm
<b>12</b>	Exhaust fumes d.8 cm
<b>13</b>	Hole combustion air inlet d.6 cm
<b>14</b>	31 cm



**Fig. 15 - General dimensions: Roxy**

LEGEND	Fig. 15
1	72,7 cm
2	94,5 cm
3	27,4 cm
4	13,5 cm
5	17,1 cm
6	29,8 cm
7	19,7 cm
8	76 cm
9	17,3 cm
10	76 cm
11	13,2 cm
12	Exhaust fumes d.8 cm
13	Hole combustion air inlet d.6 cm
14	31 cm

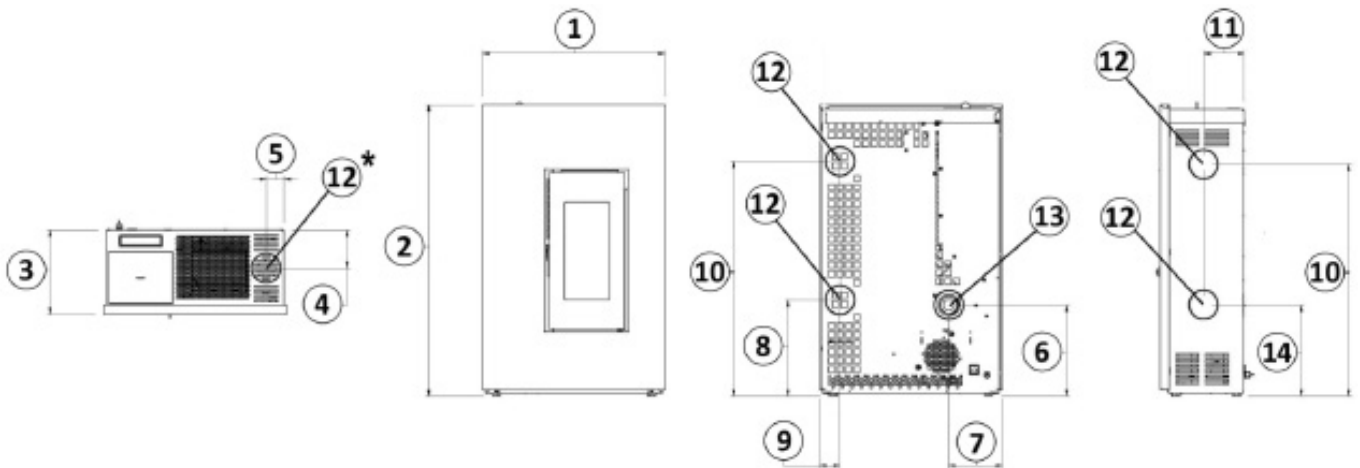


**Fig. 16 - General dimensions: Tabla**

LEGEND	Fig. 16
1	71 cm
2	95,5 cm
3	27,5 cm
4	12,5 cm
5	14,5 cm
6	30 cm
7	18,7 cm
8	76 cm
9	16,5 cm
10	76 cm
11	13,2 cm
12	Exhaust fumes d.8 cm

**LEGEND Fig. 16**

<b>13</b>	Hole combustion air inlet d.6 cm
<b>14</b>	31 cm



**Fig. 17 - General dimensions: SOLO 5 - MADISON 5**

**LEGEND Fig. 17**

<b>1</b>	60 cm
<b>2</b>	95,5 cm
<b>3</b>	27,5 cm
<b>4</b>	12,5 cm
<b>5</b>	6 cm
<b>6</b>	30 cm
<b>7</b>	17,5 cm
<b>8</b>	31,5 cm
<b>9</b>	6,5 cm
<b>10</b>	76 cm
<b>11</b>	13,2 cm
<b>12</b>	Exhaust fumes d.8 cm
<b>13</b>	Hole combustion air inlet d.6 cm
<b>14</b>	31 cm

## 6.4 STOVE DOOR REMOVAL/INSTALLATION

### DOOR REMOVAL

For some operations (e.g.: side panel assembly and cleaning) you must remove the stove door.

To remove the door:

- Open the door.
- Use a screwdriver to rotate the lever in the direction of the arrow (vedi **Fig. 18**).
- Lift the door to allow the door pivots to slide out of the structure bracket (see **Fig. 19**).
- Keep the door in a safe place until next use.



**Fig. 18 - Remove screws**



**Fig. 19 - Door removal**

## DOOR ASSEMBLY

To assemble the door you must centre the pivots fixed to the door, on the structure bracket. After having mounted the door with the screwdriver, lift the lever so that the door is locked.

## 6.5 GRACE<sup>3</sup> FRAME ASSEMBLING

### METAL

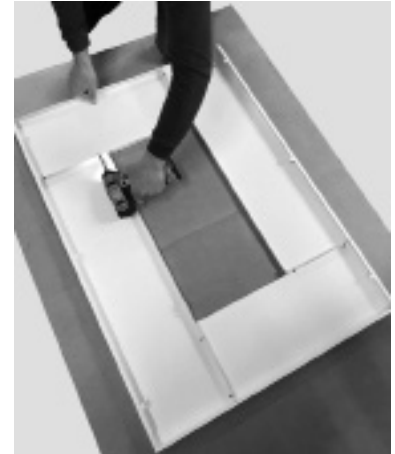
- Remove the door (see the dedicated chapter).
- Place the coloured panels on a top (see **Fig. 20**).
- Fix the 4 panels together using the supplied screws (see **Fig. 21** and **Fig. 22**).



*Fig. 20 - Panels on top*

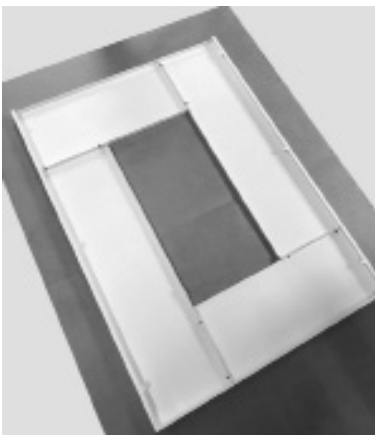


*Fig. 21 - Panel 1 fixing*



*Fig. 22 - Panel 2 fixing*

- Once the frame is made (see **Fig. 23**), hook it to the stove using the special teeth (see **Fig. 24**).
- Lock the frame with 2 screws (see **Fig. 25**).
- Follow the procedure in reverse order to remove.



*Fig. 23 - Completed frame*



*Fig. 24 - Frame fixing to the stove*

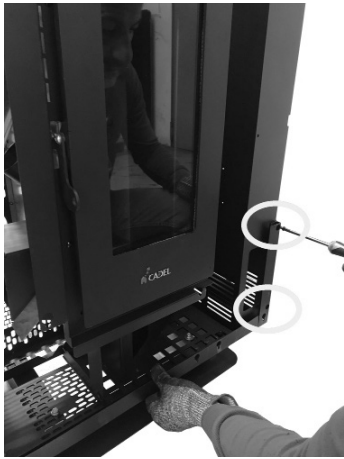


*Fig. 25 - Screw tightening*

### STONE

- Fix the lower brackets (see **Fig. 26**) and the upper brackets (see **Fig. 27**) supporting the stone.



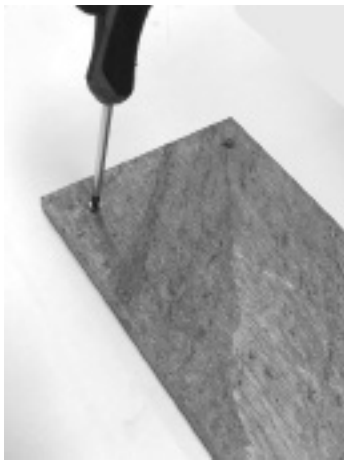


**Fig. 26 - Lower bracket fixing**

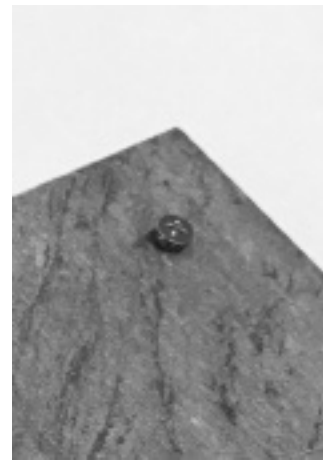


**Fig. 27 - Upper bracket fixing**

- Tighten the screws to the stone (see **Fig. 28**), the screw head must protrude about 1.5 mm (see **Fig. 29**).



**Fig. 28 - Tighten the screws**

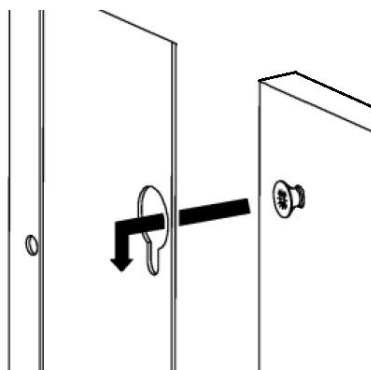


**Fig. 29 - The screw must protrude**

- Take the stone and fit the screw head in the appropriate hole in the brackets (see **Fig. 30** and **Fig. 31**).
- Proceed in the same way for all the stones (see **Fig. 32**).
- Follow the procedure in reverse order to remove.



**Fig. 30 - Hook the stone**



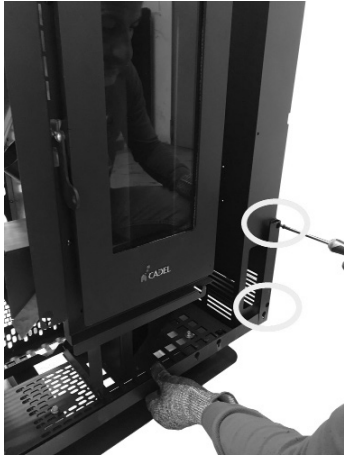
**Fig. 31 - Detail of the hooking**



**Fig. 32 - Hook all the stones**

## GLASS

- Fix the lower brackets (see **Fig. 33**) and the upper brackets (see **Fig. 34**) supporting the glass.



**Fig. 33 - Lower bracket fixing**



**Fig. 34 - Upper bracket fixing**

- Tighten the screws to the glass (see **Fig. 35**), the screw head must protrude about 1.5 mm (see **Fig. 36**).



**Fig. 35 - Tighten the screws**

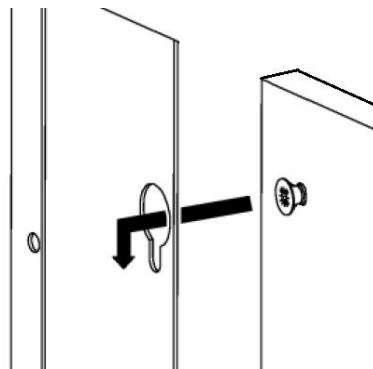


**Fig. 36 - The screw must protrude**

- Take the glasses and fit the screw head in the appropriate hole in the brackets (see **Fig. 37** and **Fig. 38**).
- Proceed in the same way for all the glasses (see **Fig. 39**).
- Follow the procedure in reverse order to remove.



**Fig. 37 - Hook the glass**



**Fig. 38 - Detail of the hooking**



**Fig. 39 - Hook all the glasses**

## 6.6 FRAME DISASSEMBLY SPIRIT<sup>3</sup> - MADISON - SOLO 5 - TABLA

- Remove the door (see the dedicated chapter).
- Loosen the 2 screws that fix the frame to the structure (see **Fig. 40**).
- Release the frame (see **Fig. 41**).
- To assemble proceed in reverse order.



**Fig. 40 - Remove the screws**



**Fig. 41 - Unhook frame**

## 6.7 ROXY - ATRIUM PANEL DISASSEMBLY

- Remove the door (see the dedicated chapter).
- Remove the 2 screws of the faceplates located under and above the door (see **Fig. 42** and **Fig. 43**) and then take them out (see **Fig. 44**).



**Fig. 42 - Screw removal 1**



**Fig. 43 - Screw removal 2**



**Fig. 44 - Faceplates removal**

- Loosen the 3 screws that fix the frame to the structure (see **Fig. 45**).
- Loosen the 3 screws behind the stove (see **Fig. 46**) and remove the panel (see **Fig. 47**).
- To assemble proceed in reverse order.



**Fig. 45 - Screw removal 3**



**Fig. 46 - Screw removal 4**



**Fig. 47 - Panel removal**

## 6.8 UPPER EXHAUST

The stoves with the upper smoke exhaust are available in 2 versions:



Fig. 48 - Version 1



Fig. 49 - Version 2

For installation of stoves with the upper smoke exhaust, proceed as follows:

- **GRACE**: with the help of clamps, break the grid near the exhaust (see Fig. 50). There are precuts under the grid that facilitate its removal.
- **SPIRIT - ATRIUM - ROXY**: with the help of clamps, break the pre-cut on the top (see Fig. 51).
- Once the passage is open, insert the d.80 mm pipe of the smoke exhaust (see Fig. 52).



Fig. 50 - Remove grid

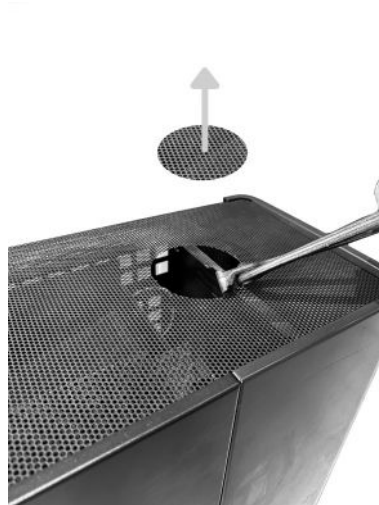


Fig. 51 - Break the pre-cut



Fig. 52 - Insert pipe

## 6.9 ASSEMBLY OF THE GRACE PEDESTAL<sup>3</sup> (OPTIONAL) AND ROXY STAND

Proceed as follows to assemble the pedestal:

- Lay the stove down on its back.
- Match the pedestal holes to those on the stove base (see Fig. 53).
- With the 2 hexagonal screws and relative bolts (see Fig. 54), lock the pedestal to the base (see Fig. 55).



**Fig. 53 - Position the stand**



**Fig. 54 - Hexagonal screw and bolt**



**Fig. 55 - Lock screws**

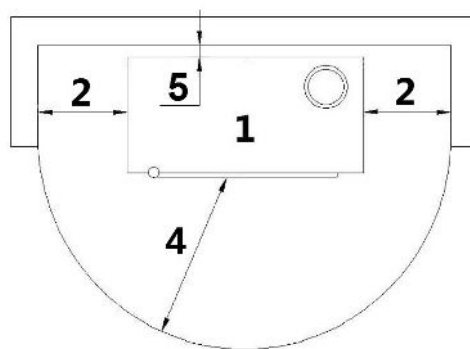
- Stand the stove up and with 2 screws lock the pedestal to the back (see **Fig. 56**).



**Fig. 56 - Secure the screws**

## 6.10 GRACE<sup>3</sup> WALL MOUNTING (OPTIONAL)

The stove is suitable for wall mounting. The can be attached to a load-bearing wall in masonry (NOT plasterboard, wood, etc...) suitable for the entire weight of the stove.



**Fig. 57 - Wall mounting**

LEGEND	Fig. 57
1	Stove
2	Minimum lateral distance = 300 mm
4	Minimum front distance = 1000 mm
5	Support distance = 40 mm

- It is obligatory to install the stove away from walls and/or pieces of furniture, with a minimum air flow of 300 mm on the sides to enable an efficient appliance cooling and a good distribution of heat in the room (see **Fig. 57**).

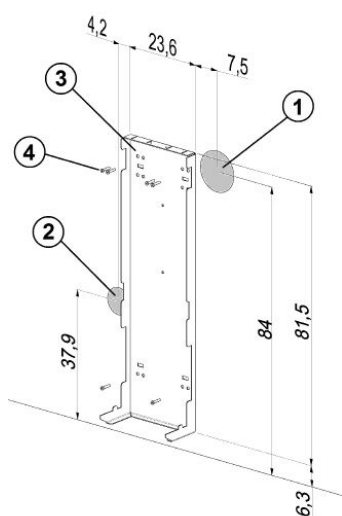


*In some countries also masonry load-bearing walls are considered flammable.*

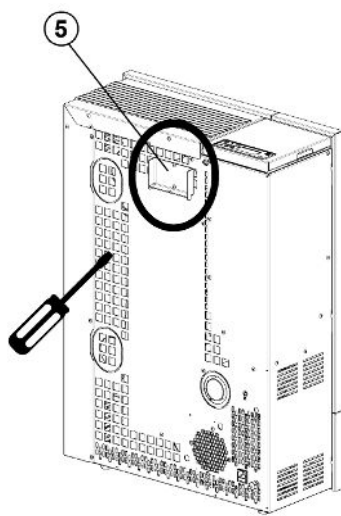
If you want to fix the stove to a non-flammable material wall, you need to fix the support to the wall (optional cod. 5019009). Call an expert to prepare the fumes outlet hole and the combustion air inlet hole.

### EXAMPLE OF INSTALLATION OF THE STOVE AT 8 CM FROM THE GROUND:

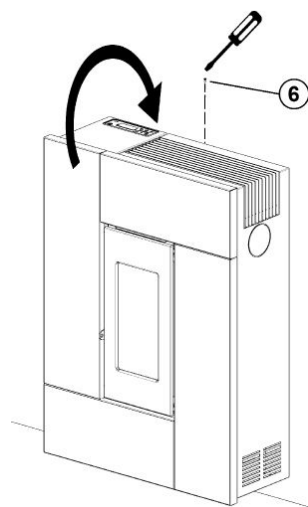
- Drill the holes in the wall for fumes extraction (ref. 1) and the combustion air (ref. 2) as indicated in **Fig. 58**.
- Fix the support to the wall (ref. 3) using metal dowels (ref. 4) suitable for bearing the stove weight.
- Secure the clamping bracket (ref. 5) on the back of the stove. Use the screws already present on the back (see **Fig. 59**).
- Lift the stove and hook it to the support (see **Fig. 60**). At this stage, also connect fumes and air combustion tubes.
- Secure everything with the screw (ref. 6).
- Follow the procedure in reverse order to remove.



**Fig. 58 - Step 1**



**Fig. 59 - Step 2**



**Fig. 60 - Step 3**

#### LEGEND Fig. 58 - Fig. 59 - Fig. 60

<b>1</b>	Hole d.120 mm for fumes extraction
<b>2</b>	Hole d.80 mm for combustion air inlet
<b>3</b>	Wall support
<b>4</b>	Metal dowels
<b>5</b>	Clamping bracket
<b>6</b>	Screw

## 6.11 ELECTRIC CONNECTION



*Warning: the appliance must be installed by an authorized technician!*

- The electric connection occurs through a cable with plug put in an electric socket which is able to support charge and tension specific of every model, as described in the technical datas table (see **REPAIR INFORMATION a pag. 30**).
- The plug must be easily accessible when the appliance is installed.
- Please further assure you that your network is endowed with an efficient earth connection: if it does not exist or if it is not efficient, please endow you with one in compliance with the law.
- Connect the supply cable first on the back of the stove (see **Fig. 61** and **Fig. 62**) and then at a wall electric socket.



**Fig. 61 - Electric socket with master switch**



**Fig. 62 - Plug connected**

- Do not use extension cables.
- If the feeder cable is damaged, it must be replaced by an authorized technician.
- When the stove is not going to be used for a long period of time, it is advisable to remove the plug from the socket on the wall.
- An electrical connection to a UPS/ACCUMULATOR/ STABILISER must guarantee a voltage of at least 210 V without power surges. Considering the variety of UPS on the market regarding size and construction qualities, we cannot guarantee operation once the stove is connected to these devices.

## 6.12 CONNECTION TO THE EXTERNAL THERMOSTAT



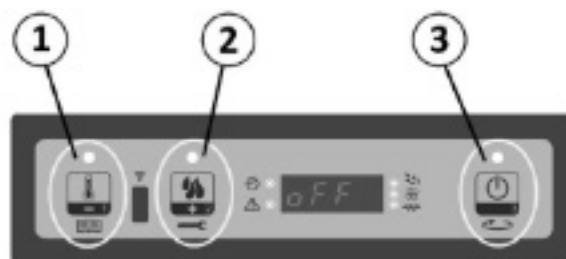
**Fig. 63 - Graphic display**

The stove works through a thermostat probe placed in its inner. If you desire, the stove can be connected to an external room thermostat. This operation must be executed by an authorized technician.

Connect the wires from the external thermostat to the "Term opt" terminal on the stove board. Activate the external thermostat (default setting OFF) as indicated below:

- Press the **"menu"** button.
- Scroll with the arrows to **"Settings"**.
- Select by pressing **"menu"**.
- Scroll with the arrows again to **"Ext.Thermostat"**.
- Select by pressing **"menu"**.
- Press the - + buttons.
- To activate the external thermostat select **"on"**.
- Press the **"menu"** button to confirm.

## 6.13 CONNECTION TO THE EXTERNAL THERMOSTAT



**Fig. 64 - 3-key display**

The stove works through a thermostat probe placed in its inner. If you desire, the stove can be connected to an external room thermostat. This operation must be executed by an authorized technician.

Connect the wires from the external thermostat to the "Term opt" terminal on the stove board. Activate the external thermostat (default setting OFF) as indicated below:

- Press the menu key for a few seconds (1).
- Repeatedly press the P2 key until **M8 - Technical settings "M8-SEt tEChnic"** appears.
- Select by pressing the P3 key.
- Set the password with keys P1 or P2 (keeping the key pressed accelerates the setting).

- Confirm by pressing the P3 key.
- Press the P1 or P2 keys until **M8 - 2 General settings** "M8-2 SEt GEnErAL" appears.
- Confirm with P3.
- Scroll with the P3 key up to: **Pr46 Enable Remote** "Pr46 rEMoto EnAbLEd".
- Press the P1 or P2 key to modify the status.
- Confirm with the P3 key.
- Scroll to **MB Output** "Mb ESCAPE" with key P1 or P2.
- Confirm with P3 key.
- 
- Press P1 (temperature setting) and set **t-e** "t-E" value. The external thermostat is now enabled.

## 6.14 STOVE CALIBRATION AND DEPRESSION MEASUREMENT

This stove has a pickup point positioned on the tank in order to measure the depression of the combustion chamber and verify its proper operation.

To do this, proceed as follows:

- The depression detection point is located behind the pellet tank.
- Connect a digital pressure switch with a tube to detect the depression (see **Fig. 65**).
- Load the feed screw via appropriate function.
- Start the stove and set "Fire" at power 1 (the start of this stove lasts from 8 to 10 minutes to ensure minimum draught).
- Compare the read values with those on the table.
- Change power every 10 minutes and wait for it to stabilise.
- Access the user menu and, if necessary, change the parameters.



Fig. 65 - Connecting the digital pressure switch

DATA	P1	P2	P3	P4	P5
Stove depression - temperature 5,2 kW	20 Pa - 160°C	22 Pa - 170°C	24 Pa - 190°C	29 Pa - 195°C	33 Pa - 210°C
Stove depression - temperature 7 kW	25/26 Pa - 190°C	29/30 Pa - 200°C	34/35 Pa - 220°C	40/41 Pa - 240°C	47/48 Pa - 250°

NB: for good combustion, the depression values must be between + -5 Pa and the temperature values between + - 10°C.

## 7 SPECIAL MAINTENANCE

### 7.1 INTRODUCTION

For a long working life of the stove, have a periodic cleaning of the stove as described in the following paragraphs.

- Fume outlet pipes (fume conduit + chimney flue + chimney pot) must always be cleaned, scrubbed and checked by an authorized technician in compliance with local regulations, with the instructions of the manufacturer and those of your insurance company.
- If there are no local regulations and no instruction from your insurance company, it is necessary to have your fume pipe, chimney flue and chimney pot cleaned at least once a year.
- It is also necessary to have the combustion chamber, motors and fans cleaned and to have the gaskets and the electrical elements checked at least once a year.





*All these operations must be planned in time with your Authorized Technical Assistance Service.*

- After a long ineffective time, before turning on the stove check if there are obstructions in the fume exhaust.
- If the stove had been using continuously and intensely, the whole system (chimney included), must be cleaned and checked more frequently.
- In case of replacement of damaged pieces please ask for the original spare part at the Authorized Retailer.

## 7.2 FUME CONDUIT CLEANING

The exhaust system must be cleaned every 2/3 months.



**Fig. 66 - Fume conduit cleaning**

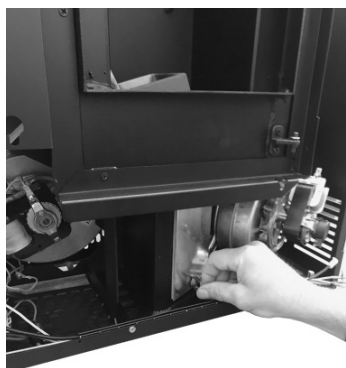
- Remove the inspection lid of the T-union (see **Fig. 66**).
- Extract the ash which has accumulated in the inner.
- After cleaning repeat the operation in reverse order, checking the condition and efficiency of the gasket, and if necessary replace it.



*It is important to sealed the cap otherwise noxious fumes will propagate among the room.*

## 7.3 FUME PASSAGES CLEANING

Clean the fume passages every year.



**Fig. 67 - Remove the inspection cap**



**Fig. 68 - Vacuum out the ash**

- Remove the door and the front coating (see dedicated chapters).
- Loosen the screws and remove the inspection cap (see **Fig. 67**).
- Vacuum the ash accumulated inside (see **Fig. 68**).



**Fig. 69 - Remove screw 1**



**Fig. 70 - Remove screw 2**



**Fig. 71 - Clean with pipe cleaner**

- To clean the smoke passage inside the combustion chamber, loosen the 2 screws (see **Fig. 69** and **Fig. 70**) and move the right wall enough to have access with a pipe cleaner (see **Fig. 71**).
- Clean and vacuum any ash accumulated inside.
- After cleaning, repeat the operation in reverse making sure the gasket is intact and efficient: if necessary, provide for the replacement with original spare parts.

## 7.4 HOW TO CLEAN THE ROOM FAN

Clean every the year the room fan from ash or dust which can cause a blade unbalance and a greater noise.

### MODELS (SPIRIT3 - ATRIUM - MADISON - SOLO 5)

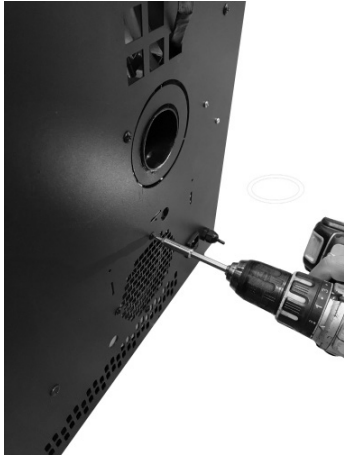
- Remove the door and the front coating (see dedicated chapters).
- Vacuum the ash and dust accumulated in the fan (see **Fig. 72**).



**Fig. 72 - Room fan cleaning**

### MODELS (GRACE3 - ROXY - TABLA)

- Remove the door and the front coating (see dedicated chapters).
- The room fan is fixed to the back of the stove, to remove it loosen the 4 screws behind the stove (see **Fig. 73**).
- Remove the fan and vacuum the ash and dust accumulated in the fan (see **Fig. 74**).



**Fig. 73 - Remove the screws**



**Fig. 74 - Room fan cleaning**

## 7.5 FUME PIPES ANNUAL CLEANING

Clean annually from soot with brushes.

The cleaning operation must be executed by a specialized stove-repairer who will provide for the cleaning of fume pipe, chimney flue and chimney pot. He will also check their efficiency and will release a written declaration of the safety of the appliance. This operation must be executed at least once a year.

## 7.6 GASKET REPLACEMENT

In case of deterioration of fire door, hopper or fume chamber gaskets, it is necessary to replace them by an authorized technician in order to guarantee the good running of the stove.



*Use exclusively original spare parts.*

## 8 IN CASE OF ANOMALY












### 8.1 PROBLEM SOLVING

























*Before of every Authorized Technician intervention, the same Technician has the duty to check if the parameters of the mother board correspond to those of the table you own.*



*In case of doubts regarding the use of the stove, please contact ALWAYS the Authorized Technician on order to avoi irreparable damages!*

PROBLEM	CAUSE	SOLUTION	INTERVENTION
The control display does not switch on	The stove is without power supply	Check if the plug is connected.	
	Burned protection fuse in the electric socket	Replace the protection fuses in the electric socket (3.15A-250V).	
	Faulty control display	Replace the control display.	
	Faulty flat cable	Replace the flat cable.	
	Faulty electronic board	Replace the mother board.	
Pellets do not reach the combustion chamber	Empty hopper	Full the hopper.	
	Open fire door or open pellet door	Close fire door and pellet door and check that there are no pellet grains at the gasket level.	
	Clogged stove	Fume chamber cleaning	
	Auger blocked by a foreign object (for example nails)	Clean the auger.	
	The auger geared motor is out of order	Replace the geared motor.	
	Check if on the display there is an "ACTIVE ALARM"	Have the stove checked.	

PROBLEM	CAUSE	SOLUTION	INTERVENTION
The fire extinguish and the stove stops	Empty hopper	Full the hopper.	
	Auger blocked by a foreign object (for example nails)	Clean the auger.	
	Bad quality pellets	Try other types of pellets.	
	Pellet drop value too low "phase 1"	Adjust the pellet loading.	
	Check if on the display there is an "ACTIVE ALARM"	Have the stove checked.	
	The door does not close perfectly or the gaskets are worn	Check the door seal and replace the gaskets.	
	Ignition step is not completed	Empty the brazier and repeat ignition.	
	Clogged exhaust	The exhaust chimney is partially or totally obstructed. Call a skilled chimney technician to check from the stove exhaust to the chimney pot. Clean immediately.	
Flames are weak and orange coloured, pellets do not burn properly and the glass blackens	Not sufficient combustion air	Check as following: probable obstructions of the combustible air inlet from the back or from the bottom of the stove; burning pot obstructed holes with too ash remains. Have the fan blades and auger cleaned. (see SMOKE RPM VARIATION User Manual)	
	Obstructed exhaust	The exhaust chimney is partially or totally obstructed. Contact an expert stove-repairer who checks the stove from the exhaust up to the chimney pot. Provide immediately for stove cleaning.	
	Obstructed stove	Provide immediately at the inner cleaning of the stove.	
	The fume fan is out of order	The pellets can burn also thanks to chimney flue depression without the aid of the fume fan. Have the fume fan immediately replaced. It can be noxious to health to let the stove running without fume fan.	
The exchanger fan continues to turn even though the stove has just cooled	Faulty fume temperature probe	Replace the fume probe.	
	Faulty mother board	Replace the mother board.	
Ash remains along the stove	Faulty or out of order door gaskets	Replace the gaskets.	
	Not sealed fume pipes	Contact an expert stove-repairer who will immediately provide for sealing the junctions with high-temperature silicone and/or for replacing pipes with those in compliance to current regulations. A not sealed fume channelisation can be noxious to health.	

PROBLEM	CAUSE	SOLUTION	INTERVENTION
The stove is at its highest power but does not heat up.	Ambient temperature reached.	The stove is at its minimum value. Increase the desired ambient temperature.	
Stove running and display showing "Smoke Overtemperature"	Reached fume outlet limit temperature	The stove runs at minimum. NO PROBLEM!	
The stove's smoke duct produces condensation	Low smoke temperature	Check that the flue is not clogged.	
		Increase stove power to minimum (pellet drop and fan revs).	
		Install condensation collection cup.	
Stove running and display showing "SERVICE"	Routine maintenance alert (it does not block the system)	When this flashing message appears upon start-up, it means that the preset operating hours have elapsed before maintenance. Contact the service centre.	

## 9 TECHNICAL DATAS

### 9.1 REPAIR INFORMATION

Now we give some instructions for the Authorized Technician to take into consideration to have access to stove mechanical components.

- For fuse replacement in the electric socket which stands on the back of the stove, extract the fuses to change with the aid of a screwdriver for opening the shutter (see **Fig. 75**).



**Fig. 75 - Shutter with fuses to remove**

Proceed as follows:

- Remove the frame (see the dedicated chapters).
- After these operations you can have access at the following components: geared motor, ignition plug, ambient fan, fume fan, ambient probe, fume probe, thermostat, electronic board, pressostat.
- For cleaning or replacement of the auger it is necessary to unscrew the three bolt of the geared motor and to extract it, unscrew the two screws lying under the geared motor (vedi **Fig. 76**), of the auger, remove the hand rejector inside the hopper and then unscrew the inner bolt of the auger. (vedi **Fig. 77**). To assembly proceed at the contrary.

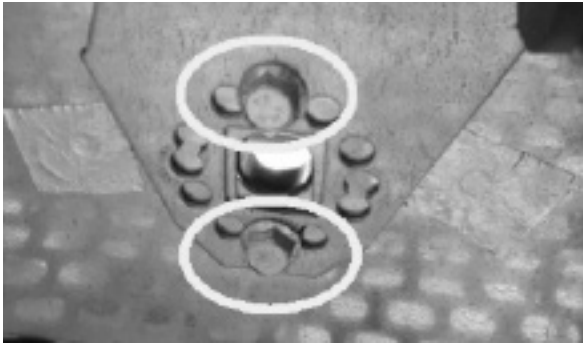


Fig. 76 - Remove the screws



Fig. 77 - Remove the screw

## 10 FEATURES

DESCRIPTION	GRACE 7	ROXY	TABLA
WIDTH	69 cm	72,7 cm	71 cm
DEPTH	27,5 cm	27,4 cm	27,5 cm
HEIGHT	98,7 cm	94,5 cm	95,5 cm
WEIGHT	63,5 - 80 kg	63 kg	60 kg
INTRODUCED THERMIC POWER (Min/Max)	2,8 - 7,82 kW	2,8 - 7,82 kW	2,8 - 7,82 kW
NOMINAL THERMIC POWER (Min/Max)	2,7 - 7 kW	2,7 - 7 kW	2,7 - 7 kW
EFICIENCY (Min/Max)	93 - 89,5 %	93 - 89,5 %	93 - 89,5 %
FUME TEMPERATURE (Min/Max)	87 - 182 °C	87 - 182 °C	87 - 182 °C
FUME MAXIMUM LOADING CAPACITY (Min/Max)	3 - 4,9 g/s	3 - 4,9 g/s	3 - 4,9 g/s
CO EMISSIONS (13% O <sub>2</sub> ) (Min/Max)	0,0146 - 0,0103 %	0,0146 - 0,0103 %	0,0146 - 0,0103 %
OGC EMISSIONS (13% O <sub>2</sub> ) (Min/Max)	7 - 4 mg/Nm <sup>3</sup>	7 - 4 mg/Nm <sup>3</sup>	7 - 4 mg/Nm <sup>3</sup>
NO <sub>x</sub> EMISSIONS (13% O <sub>2</sub> ) (Max)	116 mg/Nm <sup>3</sup>	116 mg/Nm <sup>3</sup>	116 mg/Nm <sup>3</sup>
Medium CO CONTENTS at 13% O <sub>2</sub> (Min/Max)	183 - 129 mg/Nm <sup>3</sup>	183 - 129 mg/Nm <sup>3</sup>	183 - 129 mg/Nm <sup>3</sup>
Medium POWDER CONTENTS at 13% O <sub>2</sub> (Max)	14 mg/Nm <sup>3</sup>	14 mg/Nm <sup>3</sup>	14 mg/Nm <sup>3</sup>
CHIMNEY DEPRESSION (Max)	11 Pa	11 Pa	11 Pa
ON SHARED CHIMNEY FLUE	NO	NO	NO
FUME OUTLET DIAMETER	Ø80 mm	Ø80 mm	Ø80 mm
COMBUSTIBLE	Pellet Ø6-7 mm	Pellet Ø6-7 mm	Pellet Ø6-7 mm
PELLETS HEATING VALUE	5 kWh/kg	5 kWh/kg	5 kWh/kg
PELLETS HUMIDITY	≤ 10%	≤ 10%	≤ 10%
HEATING VOLUME 18/20°C Coeff. 0,045 kW (Min/Max)	65 - 168 m <sup>3</sup>	65 - 168 m <sup>3</sup>	65 - 168 m <sup>3</sup>
HOURLY CONSUMPTION (Min/Max)	0,61 - 1,7 kg/h	0,61 - 1,7 kg/h	0,61 - 1,7 kg/h
HOPPER CAPACITY	12 kg	12 kg	12 kg
RANGE (Min/Max)	19,7 - 7,1 h	19,7 - 7,1 h	19,7 - 7,1 h
SUPPLY	230 V - 50 Hz	230 V - 50 Hz	230 V - 50 Hz
POWER INPUT (Max)	345 W	345 W	345 W
INGNITER RESISTANCE POWER INPUT	300 W	300 W	300 W
MINIMUM EXTERNAL AIR INLET (last effective area)	80 cm <sup>2</sup>	80 cm <sup>2</sup>	80 cm <sup>2</sup>
STOVE WITH SEALED CHAMBER	YES	YES	YES
EXTERNAL AIR INLET FOR SEALED CHAMBER	60 mm	60 mm	60 mm
DISTANCE FROM COMBUSTIBLE MATERIAL (back/side/bottom)	40 / 300 / 0 mm	40 / 300 / 0 mm	40 / 300 / 0 mm
DISTANCE FROM COMBUSTIBLE MATERIAL (ceiling/front)	- / 1000 mm	- / 1000 mm	- / 1000 mm

DESCRIPTION	SPIRIT 5	ATRIUM 5	SOLO5/MADISON5
WIDTH	60 cm	64,5 cm	60 cm
DEPTH	27,5 cm	27,7 cm	27,5 cm
HEIGHT	95,8 cm	94 cm	95,5 cm
WEIGHT	55 kg	59 kg	55 kg
INTRODUCED THERMIC POWER (Min/Max)	2,9 - 5,8 kW	2,9 - 5,8 kW	2,9 - 5,8 kW
NOMINAL THERMIC POWER (Min/Max)	2,5 - 5,2 kW	2,5 - 5,2 kW	2,5 - 5,2 kW
EFICIENCY (Min/Max)	91,5 - 89,5 %	91,5 - 89,5 %	91,5 - 89,5 %
FUME TEMPERATURE (Min/Max)	105 - 166 °C	105 - 166 °C	105 - 166 °C
FUME MAXIMUM LOADING CAPACITY (Min/Max)	2,7 - 4,1 g/s	2,7 - 4,1 g/s	2,7 - 4,1 g/s
CO EMISSIONS (13% O <sub>2</sub> ) (Min/Max)	0,0188 - 0,0113 %	0,0188 - 0,0113 %	0,0188 - 0,0113 %
OGC EMISSIONS (13% O <sub>2</sub> ) (Min/Max)	7 - 4 mg/Nm <sup>3</sup>	7 - 4 mg/Nm <sup>3</sup>	7 - 4 mg/Nm <sup>3</sup>
NO <sub>x</sub> EMISSIONS (13% O <sub>2</sub> ) (Max)	123 mg/Nm <sup>3</sup>	123 mg/Nm <sup>3</sup>	123 mg/Nm <sup>3</sup>
Medium CO CONTENTS at 13% O <sub>2</sub> (Min/Max)	235 - 141 mg/Nm <sup>3</sup>	235 - 141 mg/Nm <sup>3</sup>	235 - 141 mg/Nm <sup>3</sup>
Medium POWDER CONTENTS at 13% O <sub>2</sub> (Max)	17 mg/Nm <sup>3</sup>	17 mg/Nm <sup>3</sup>	17 mg/Nm <sup>3</sup>
CHIMNEY DEPRESSION (Max)	10 Pa	10 Pa	10 Pa
ON SHARED CHIMNEY FLUE	NO	NO	NO
FUME OUTLET DIAMETER	Ø80 mm	Ø80 mm	Ø80 mm
COMBUSTIBLE	Pellet Ø6-7 mm	Pellet Ø6-7 mm	Pellet Ø6-7 mm
PELLETS HEATING VALUE	5 kWh/kg	5 kWh/kg	5 kWh/kg
PELLETS HUMIDITY	≤ 10%	≤ 10%	≤ 10%
HEATING VOLUME 18/20°C Coeff. 0,045 kW (Min/Max)	60 - 125 m <sup>3</sup>	60 - 125 m <sup>3</sup>	60 - 125 m <sup>3</sup>
HOURLY CONSUMPTION (Min/Max)	0,62 - 1,24 kg/h	0,62 - 1,24 kg/h	0,62 - 1,24 kg/h
HOPPER CAPACITY	12 kg	12 kg	12 kg
RANGE (Min/Max)	19,4 - 9,7 h	19,4 - 9,7 h	19,4 - 9,7 h
SUPPLY	230 V - 50 Hz	230 V - 50 Hz	230 V - 50 Hz
POWER INPUT (Max)	345 W	345 W	345 W
IGNITER RESISTANCE POWER INPUT	300 W	300 W	300 W
MINIMUM EXTERNAL AIR INLET (last effective area)	80 cm <sup>2</sup>	80 cm <sup>2</sup>	80 cm <sup>2</sup>
STOVE WITH SEALED CHAMBER	YES	YES	YES
EXTERNAL AIR INLET FOR SEALED CHAMBER	60 mm	60 mm	60 mm
DISTANCE FROM COMBUSTIBLE MATERIAL (back/side/bottom)	40 / 300 / 0 mm	40 / 300 / 0 mm	40 / 300 / 0 mm
DISTANCE FROM COMBUSTIBLE MATERIAL (ceiling/front)	- / 1000 mm	- / 1000 mm	- / 1000 mm











89022195B

Rev. 00-2024

**CADEL srl**  
**31025 S. Lucia di Piave - TV**  
**Via Martiri della Libertà, 74 - Italy**  
**Tel. +39 0438 1520200**

**[www.cadelsrl.com](http://www.cadelsrl.com)**  
**[www.free-point.it](http://www.free-point.it)**  
**[www.pegasoheating.com](http://www.pegasoheating.com)**